

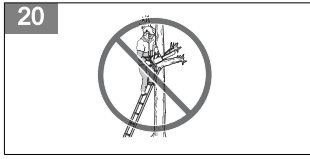

EasiSaw 350E

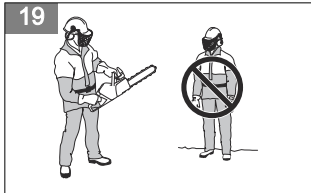

21

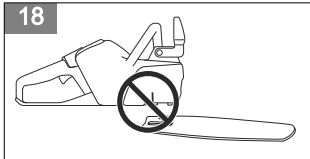
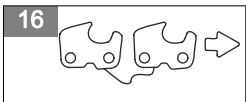
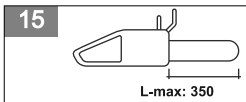
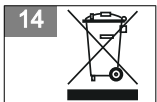
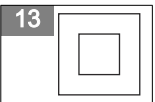
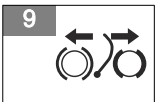
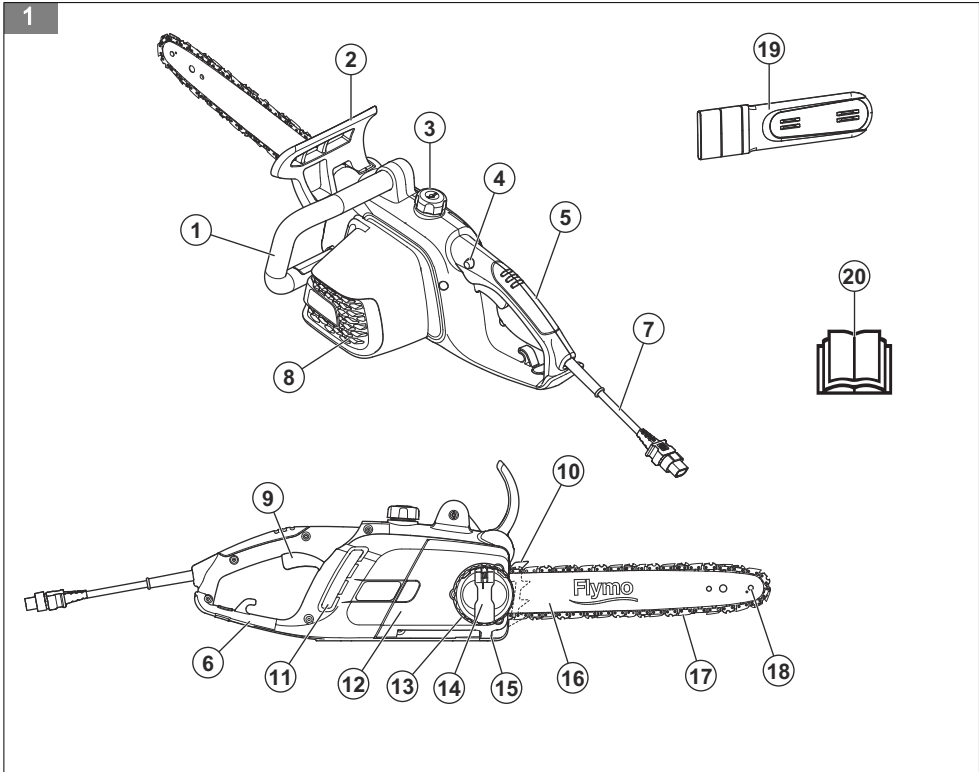

29

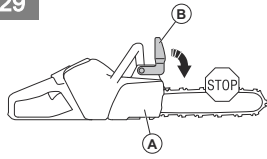

36

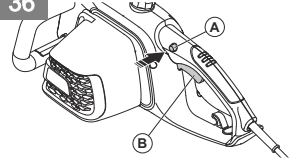

22

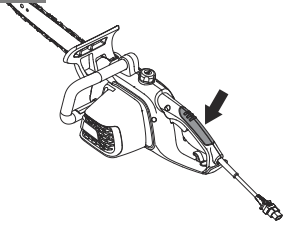

30



37

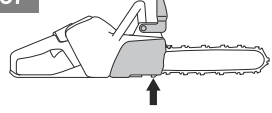

23



31

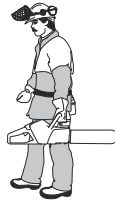

38

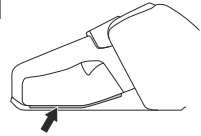

24

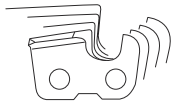

32



39



25



33



40



26



34



41



27

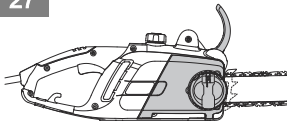

35



42



28

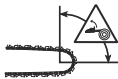

43

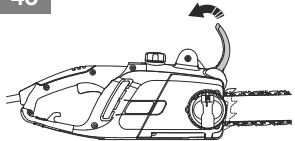

44

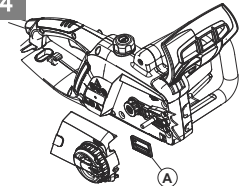

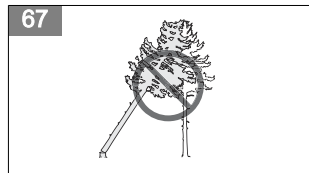
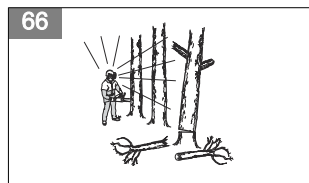
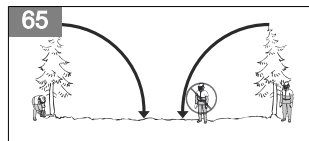
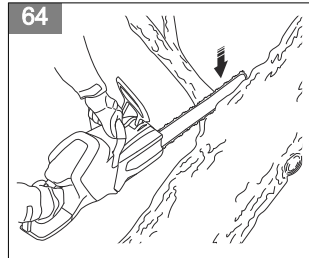
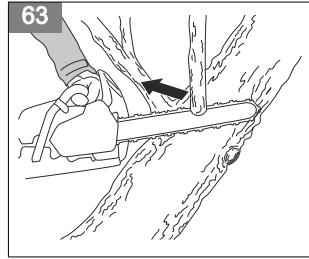
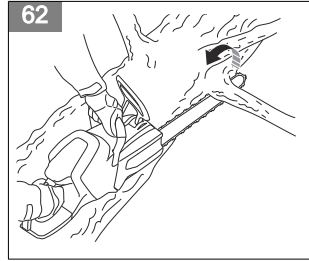
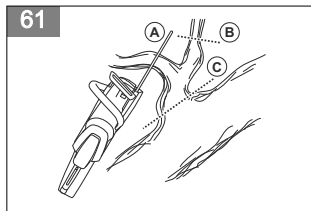
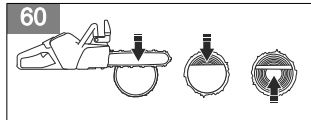
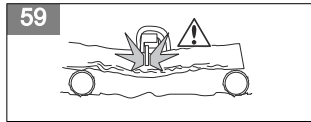
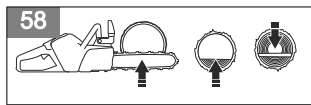
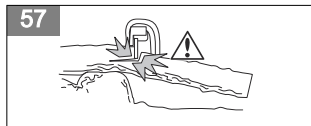
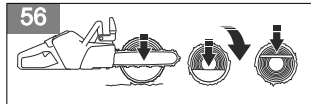
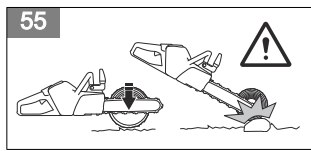
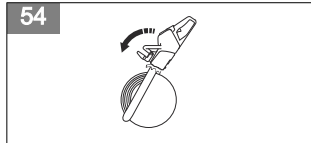
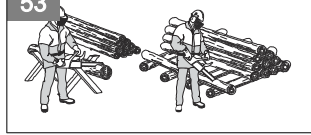
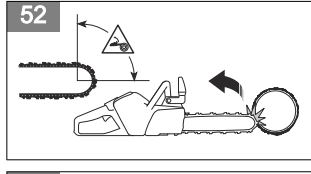
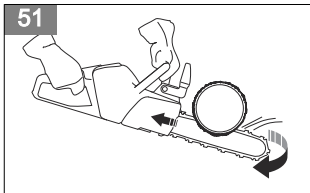
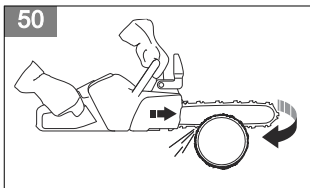
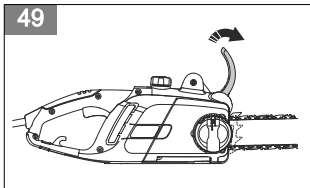
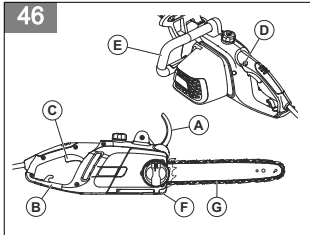
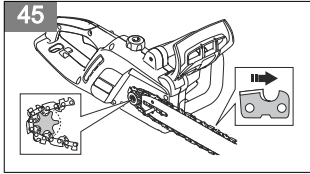

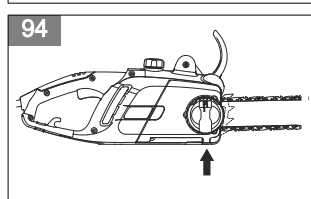
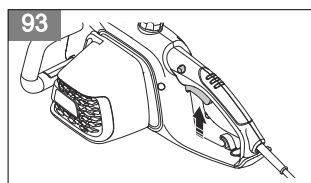
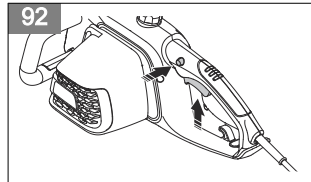
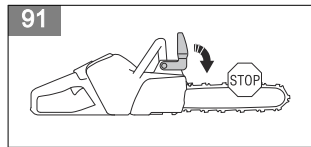
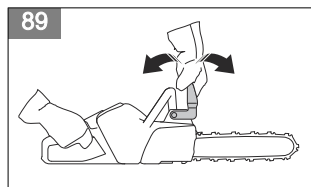
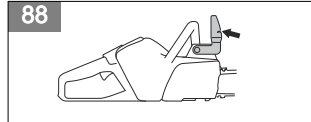
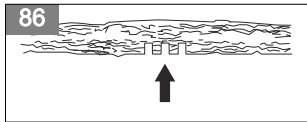
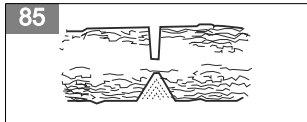
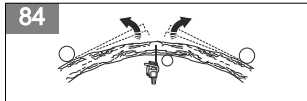
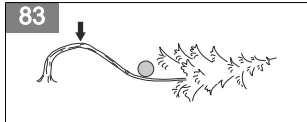
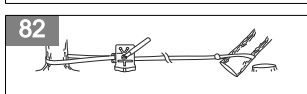
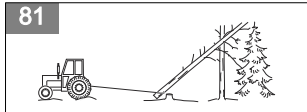
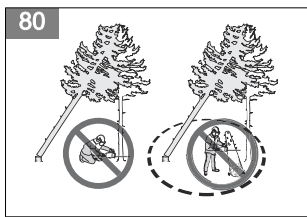
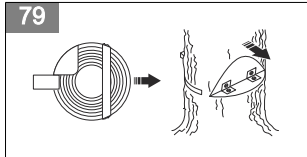
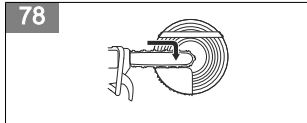
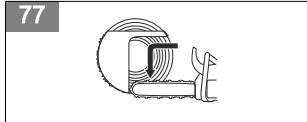
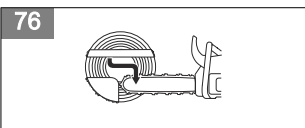
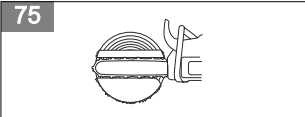
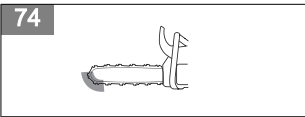
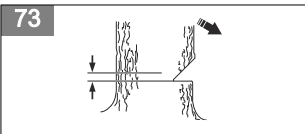
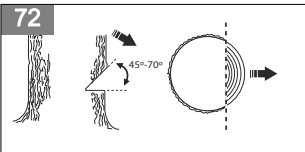
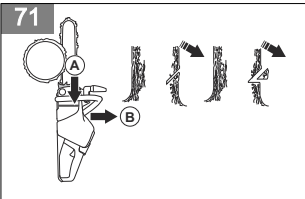
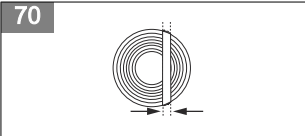
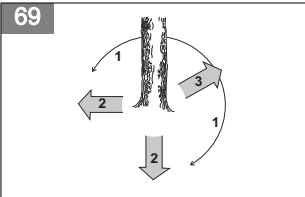
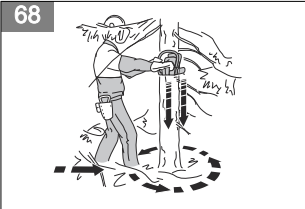

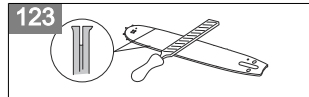
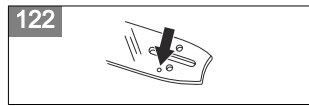
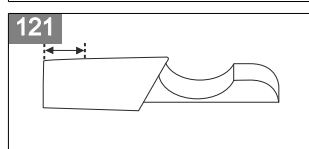
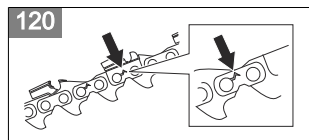
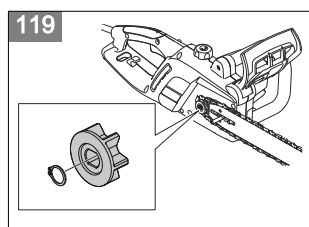
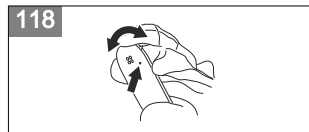
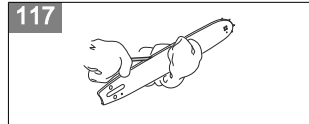
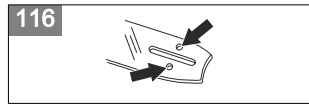
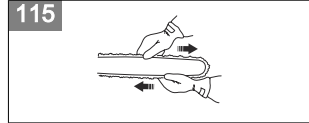
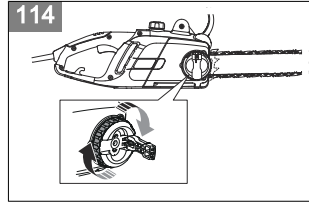
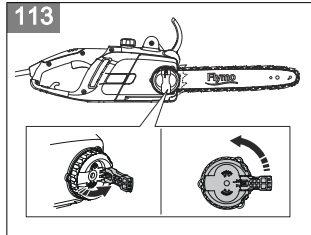
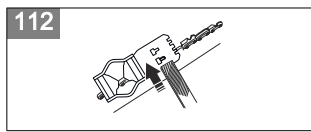
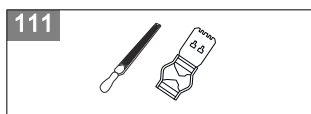
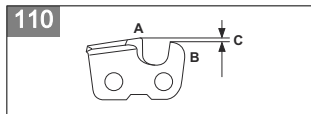
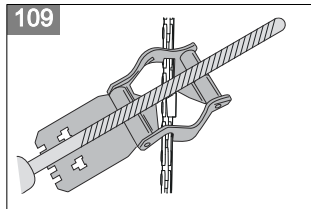
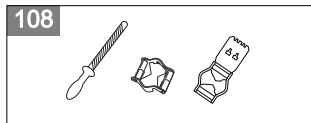
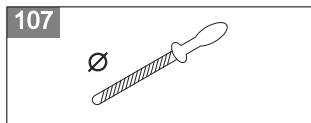
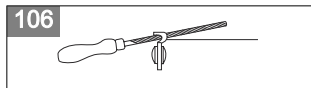
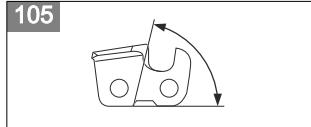
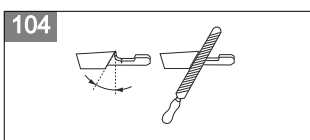
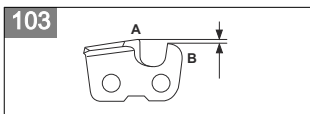
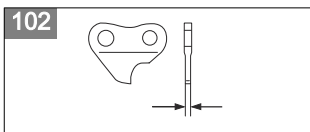
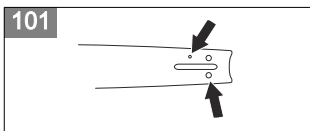
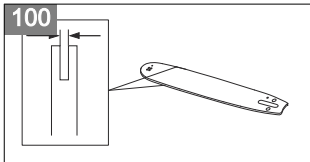
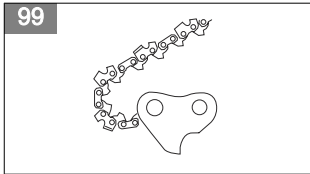
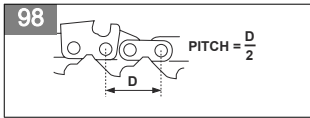
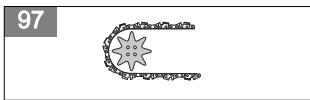
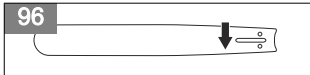
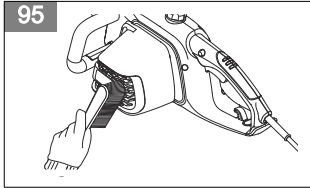

124



126



125

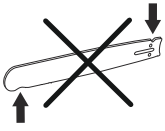

127

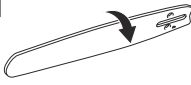

---

## Contents

---

Introduction.....	8	Troubleshooting.....	23
Safety.....	9	Transportation, storage and disposal.....	24
Assembly.....	14	Technical data.....	24
Operation.....	14	Accessories.....	25
Maintenance.....	19	Declaration of Conformity.....	26

---

## Introduction

---

### Intended use

This product is intended for sawing in wood.

**Note:** National regulations can set limit to the operation of the product.

---

### Product description

Flymo EasiSaw 350E is a mains-supplied chainsaw with an electric motor.

Work is constantly in progress to increase your safety and efficiency during operation. Speak to your servicing dealer for more information.

### Product overview

(Fig. 1)

1. Front handle
2. Front hand guard
3. Cap for the chain oil tank
4. Power trigger lockout
5. Rear handle
6. Rear hand guard
7. Power cord
8. Fan housing
9. Power trigger
10. Spiked bumper
11. Inspection gauge for chain oil
12. Drive sprocket cover
13. Chain tensioning knob
14. Bar knob
15. Chain catcher
16. Guide bar
17. Saw chain
18. Bar tip sprocket
19. Transportation cover
20. Operator's manual

### Symbols on the product

- (Fig. 2)      **WARNING:** This product can be dangerous and cause serious injury or death to the operator or others. Be careful and use the product correctly.
- (Fig. 3)      Read the operator's manual carefully and make sure that you understand the instructions before you use the product.

(Fig. 4)      Use 2 hands when you operate the product.

(Fig. 5)      Wear eye protection and ear protection.

(Fig. 6)      Noise emission to the environment label as per EU (also including New South Wales Legislation) and UK directives and regulations. Noise emission data can be found on the machine label and in *Technical data on page 24*.

(Fig. 7)      Remove the power plug from the mains immediately if the cable is damaged or cut.

(Fig. 8)      **Warning!** Kickback can occur when the guide bar tip touches an object. This causes the guide bar to be thrown in the direction of the operator. Risk of serious injury or death.

(Fig. 9)      Chain brake, engaged (right). Chain brake, disengaged (left).

(Fig. 10)      Do not expose to rain.

(Fig. 11)      This product complies with applicable EC Directives.

(Fig. 12)      This product conforms to the applicable UK regulations.

(Fig. 13)      Class II tool.



- (Fig. 14) **Environmental mark.** The product or package of the product is not domestic waste. Recycle it at an approved disposal location for electrical and electronic equipment.
- (Fig. 15) The maximum length of the guide bar.
- (Fig. 16) Chain direction.
- (Fig. 17) The rating plate shows the serial number. **yyyy** is the production year, **ww** is the production week.

**Note:** Other symbols/decals on the product refer to certification requirements for some markets.

## Manufacturer

Husqvarna AB

SE-561 82, Huskvarna, Sweden, tel: +46-36-146500

## Product liability

As referred to in the product liability laws, we are not liable for damages that our product causes if:

- the product is incorrectly repaired.
- the product is repaired with parts that are not from the manufacturer or not approved by the manufacturer.
- the product has an accessory that is not from the manufacturer or not approved by the manufacturer.
- the product is not repaired at an approved service center or by an approved authority.

# Safety

## Safety definitions

Warnings, cautions and notes are used to point out specially important parts of the manual.



**WARNING:** Used if there is a risk of injury or death for the operator or bystanders if the instructions in the manual are not obeyed.



**CAUTION:** Used if there is a risk of damage to the product, other materials or the adjacent area if the instructions in the manual are not obeyed.

**Note:** Used to give more information that is necessary in a given situation.

## General power tool safety warnings



**WARNING:** Read all safety warnings, instructions, illustrations and specifications provided with this power tool. Failure to follow all instructions listed below may result in electric shock, fire and/or serious injury.

- **Save all warnings and instructions for future reference.** The term "power tool" in the warnings refers to your mains-operated (corded) power tool or battery-operated (cordless) power tool.

## Work area safety

- **Keep work area clean and well lit.** Cluttered or dark areas invite accidents.

- **Do not operate power tools in explosive atmospheres, such as in the presence of flammable liquids, gases or dust.** Power tools create sparks which may ignite the dust or fumes.
- **Keep children and bystanders away while operating a power tool.** Distractions can cause you to lose control.

## Electrical safety

- **Power tool plugs must match the outlet. Never modify the plug in any way. Do not use any adapter plugs with earthed (grounded) power tools.** Unmodified plugs and matching outlets will reduce risk of electric shock.
- **Avoid body contact with earthed or grounded surfaces, such as pipes, radiators, ranges and refrigerators.** There is an increased risk of electric shock if your body is earthed or grounded.
- **Do not expose power tools to rain or wet conditions.** Water entering a power tool will increase the risk of electric shock.
- **Do not abuse the cord. Never use the cord for carrying, pulling or unplugging the power tool. Keep cord away from heat, oil, sharp edges or moving parts.** Damaged or entangled cords increase the risk of electric shock.
- **When operating a power tool outdoors, use an extension cord suitable for outdoor use.** Use of a cord suitable for outdoor use reduces the risk of electric shock.
- **If operating a power tool in a damp location is unavoidable, use a residual current device (RCD) protected supply.** Use of a RCD reduces the risk of electric shock.

## Personal safety

- **Stay alert, watch what you are doing and use common sense when operating a power tool. Do not use a power tool while you are tired or under the influence of drugs, alcohol or medication.** A moment of inattention while operating power tools may result in serious personal injury.
- **Use personal protective equipment. Always wear eye protection.** Protective equipment such as dust mask, non-skid safety shoes, hard hat or hearing protection used for appropriate conditions will reduce personal injuries.
- **Prevent unintentional starting. Ensure the switch is in the off-position before connecting to power source and/or battery pack, picking up or carrying the tool.** Carrying power tools with your finger on the switch or energising power tools that have the switch on invites accidents.
- **Remove any adjusting key or wrench before turning the power tool on.** A wrench or a key left attached to a rotating part of the power tool may result in personal injury.
- **Do not overreach. Keep proper footing and balance at all times.** This enables better control of the power tool in unexpected situations.
- **Dress properly. Do not wear loose clothing or jewellery. Keep your hair and clothing away from moving parts.** Loose clothes, jewellery or long hair can be caught in moving parts.
- **If devices are provided for the connection of dust extraction and collection facilities, ensure these are connected and properly used.** Use of dust collection can reduce dust-related hazards.
- **Do not let familiarity gained from frequent use of tools allow you to become complacent and ignore tool safety principles.** A careless action can cause severe injury within a fraction of a second.

## Power tool use and care

- **Do not force the power tool. Use the correct power tool for your application.** The correct power tool will do the job better and safer at the rate for which it was designed.
- **Do not use the power tool if the switch does not turn it on and off.** Any power tool that cannot be controlled with the switch is dangerous and must be repaired.
- **Disconnect the plug from the power source and/or remove the battery pack, if detachable, from the power tool before making any adjustments, changing accessories, or storing power tools.** Such preventive safety measures reduce the risk of starting the power tool accidentally.
- **Store idle power tools out of the reach of children and do not allow persons unfamiliar with the power tool or these instructions to operate the power tool.** Power tools are dangerous in the hands of untrained users.

- **Maintain power tools and accessories. Check for misalignment or binding of moving parts, breakage of parts and any other condition that may affect the power tool's operation. If damaged, have the power tool repaired before use.** Many accidents are caused by poorly maintained power tools.
- **Keep cutting tools sharp and clean.** Properly maintained cutting tools with sharp cutting edges are less likely to bind and are easier to control.
- **Use the power tool, accessories and tool bits etc. in accordance with these instructions, taking into account the working conditions and the work to be performed.** Use of the power tool for operations different from those intended could result in a hazardous situation.
- **Keep handles and grasping surfaces dry, clean and free from oil and grease.** Slippery handles and grasping surfaces do not allow for safe handling and control of the tool in unexpected situations.

## Service

- **Have your power tool serviced by a qualified repair person using only identical replacement parts.** This will ensure that the safety of the power tool is maintained.

## General chain saw safety warnings

- **Keep all parts of the body away from the saw chain when the chain saw is operating. Before you start the chain saw, make sure the saw chain is not contacting anything.** A moment of inattention while operating chain saws may cause entanglement of you clothing or body with the saw chain.
- **Always hold the chain saw with your right hand on the rear handle and your left hand on the front handle.** Holding the chain saw with a reversed hand configuration increases the risk of personal injury and should never be done.
- **Hold the chain saw by insulated gripping surfaces only, because the saw chain may contact hidden wiring or its own cord.** Saw chains contacting a "live" wire may make exposed metal parts of the chain saw "live" and could give the operator an electric shock.
- **Wear eye protection. Further protective equipment for hearing, head, hands, legs and feet is recommended.** Adequate protective equipment will reduce personal injury from flying debris or accidental contact with the saw chain.
- **Do not operate a chain saw in a tree, on a ladder, from a rooftop, or any unstable support.** Operation of a chain saw in this manner could result in serious personal injury.
- **Always keep proper footing and operate the chain saw only when standing on fixed, secure and level surface.** Slippery or unstable surfaces may cause a loss of balance or control of the chain saw.
- **When cutting a limb that is under tension, be alert for spring back.** When the tension in the wood fibres

is released, the spring loaded limb may strike the operator and/or throw the chain saw out of control.

- **Use extreme caution when cutting brush and saplings.** The slender material may catch the saw chain and be whipped toward you or pull you off balance.
- **Carry the chain saw by the front handle with the chain saw switched off and away from your body. When transporting or storing the chain saw, always fit the guide bar cover.** Proper handling of the chain saw will reduce the likelihood of accidental contact with the moving saw chain.
- **Follow instructions for lubricating, chain tensioning and changing the bar and chain.** Improperly tensioned or lubricated chain may either brake or increase the chance for kickback.
- **Cut wood only. Do not use chain saw for purposes not intended. For example: do not use chain saw for cutting metal, plastic, masonry or non-wood building materials.** Use of the chain saw for operations different than intended could result in a hazardous situation.
- **Do not attempt to fell a tree until you have an understanding of the risks and how to avoid them.** Serious injury could occur to the operator or bystanders while felling a tree.

### Causes and operator prevention of kickback

Kickback may occur when the nose or tip of the guide bar touches an object, or when the wood closes in and pinches the saw chain in the cut. Tip contact in some cases may cause a sudden reverse reaction, kicking the guide bar up and back towards the operator. Pinching the saw chain along the top of the guide bar may push the guide bar rapidly back towards the operator. Either of these reactions may cause you to lose control of the saw which could result in serious personal injury. Do not rely exclusively upon the safety devices built into your saw. As a chain saw user, you should take several steps to keep your cutting jobs free from accident or injury. Kickback is the result of chain saw misuse and/or incorrect operating procedures or conditions and can be avoided by taking proper precautions as given below:

- **Maintain a firm grip, with thumbs and fingers encircling the chain saw handles, with both hands on the saw and position your body and arm to allow you to resist kickback forces.** Kickback forces can be controlled by the operator, if proper precautions are taken. Do not let go of the chain saw.
- **Do not overreach and do not cut above shoulder height.** This helps prevent unintended tip contact and enables better control of the chain saw in unexpected situations.
- **Only use replacement guide bars and saw chains specified by the manufacturer.** Incorrect replacement guide bars and saw chains may cause chain breakage and/or kickback.
- **Follow the manufacturer's sharpening and maintenance instructions for the saw chain.**

Decreasing the depth gauge height can lead to increased kickback.

### SAVE THESE INSTRUCTIONS.

### General safety instructions



**WARNING:** Read the warning instructions that follow before you use the product.

- This product is a dangerous tool if you are not careful or if you use the product incorrectly. This product can cause serious injury or death to the operator or others. It is very important that you read and understand the contents of this operator's manual.
- Do not change the product without an approval from the manufacturer. Do not use a product that has been changed by others and always use original accessories. Changes that are not approved from the manufacturer can result in serious injury or death to the operator or others.
- Long term inhalation of chain oil fumes and sawdust can cause health problems.
- This product produces an electromagnetic field during operation. This field may under some circumstances interfere with active or passive medical implants. To decrease the risk of serious injury or death, we recommend persons with medical implants to turn to their physician and the medical implant manufacturer before operating this product.

### Safety instructions for operation



**WARNING:** Read the warning instructions that follow before you use the product.

- The information in this operator's manual is not a replacement for professional knowledge and experience. If you do not feel safe in the situation that you are in, stop the product. Turn to your servicing dealer or a professional chainsaw operator. Do not attempt any task that you feel unsure of!
- Speak to your servicing dealer or Flymo customer service if you have questions about the operation of the product. We can give you information about how to operate your product effectively and safely. Participate in a training class in chainsaw operation if possible. Your servicing dealer, forestry school or your library can give you information about training materials and classes that are available.
- You must understand the effects of kickback and how to prevent them before you use this product. Refer to *Kickback information on page 15* and *Common questions about kickback on page 15* for instructions.
- Do not use a product that is defective.

- Do not touch a rotating saw chain. It can cause serious injuries or death.
- Do not use the product if you are tired, while under the influence of alcohol or drugs, medicine or anything that could have a negative effect on your vision, alertness, coordination or judgment.
- Working in bad weather is tiring and often brings added risk. Due to the added risk, it is not recommended to use the machine in very bad weather, for instance in dense fog, heavy rain, strong winds, intense cold, risk of lightning, etc.
- Do not start a product unless the guide bar, saw chain and all covers are assembled correctly. If not, the drive sprocket can come loose and cause serious injuries. Refer to *Assembly on page 14* for instructions.

(Fig. 18)

- Look around you. Make sure that there is no risk that persons or animals touch or influence on your control of the product.

(Fig. 19)

- Do not let children use or be near the product. The product is easy to start and children may be able to start it if they are not fully supervised. This can mean a risk of serious injury.
- Disconnect the power plug when you do not have full view of the product or leave the product for any length of time.
- You must be stable on your feet in order to have full control of the product. Do not use the product if you are on a ladder or in a tree. Do not use the product if you are not on stable ground.

(Fig. 20)

- If you are not careful, the risk of kickback increases. A kickback can occur if the kickback zone of the guide bar accidentally touches a branch, tree or other objects.

(Fig. 21)

- Do not hold the product with one hand. This product is not safely controlled with one hand.
- Make sure that you hold the rear handle at the grip area.

(Fig. 22)

- Do not use the product above shoulder height and do not try to cut with the guide bar tip.

(Fig. 23)

- Do not use a product in a situation where you can not call for help if an accident occur.
- Stop the product and engage the chain brake before you move the product. Hold the product with the guide bar and saw chain pointing rearward. Put on a transportation guard on the guide bar before transportation or before you move it for any distance.
- When you put the product on the ground, engage the chain brake and have a constant view of the product. Stop the product and disconnect the power

plug before you leave your product for any length of time.

- There is a risk that wood chips get stuck in the drive system. This can cause the saw chain to get stuck. Always stop the product and disconnect the power plug before you clean it.
- Make sure that you can move around safely. Examine the conditions and the terrain around you for possible obstacles such as roots, rocks, branches, ditches and more. Be careful when you do work on sloping ground.
- The vibration level increases if you cut with cutting equipment that is incorrect or not correctly sharpened. Cutting hardwoods, such as broadleaf trees, causes more vibration than cutting softwoods, such as conifers.

(Fig. 24)

- Overexposure to vibration can lead to circulatory damage or nerve damage in persons who have decreased circulation. Speak to your physician if you experience symptoms of overexposure to vibration. Such symptoms include numbness, loss of feeling, tingling, pricking, pain, loss of strength, changes in skin colour or condition. These symptoms usually occur in the fingers, hands or wrists increases in cold temperatures.
- Prevent situations which you think is beyond your capability.
- It is not possible to include each possible situation you can face when you use this product. Always be careful and use your common sense.

(Fig. 25)

## Personal protective equipment



**WARNING:** Read the warning instructions that follow before you use the product.

(Fig. 26)

- Most chainsaw accidents occur when the saw chain touches the operator. You must use approved personal protective equipment during operation. Personal protective equipment does not give you full protection from injuries but it decreases the degree of injury if an accident occurs. Speak to your servicing dealer for recommendations about which equipment to use.
- Your clothing must be close-fitting but not limit your movements. Regularly do a check of the condition of the personal protective equipment.
- Use an approved protective helmet.
- Use approved hearing protection. Long-term exposure to noise can result in permanent damage to the hearing.
- Use protective glasses or a face visor to decrease the risk of injury from thrown objects. The product can throw objects, such as wood chips, small pieces

of wood and more, at large force. This can result in serious injury, especially to the eyes.

- Use gloves with saw protection.
- Use pants with saw protection.
- Use boots with saw protection, steel toe-cap and non-slip sole.
- Always have a first-aid kit with you.
- Risk of sparks. Keep fire extinguishing tools and a shovel near to prevent forest fires.

### Safety devices on the product



**WARNING:** Read the warning instructions that follow before you use the product.

- Do not use a product with defective safety devices.
- Do a check of the safety devices regularly. Refer to *Maintenance and checks of the safety devices on the product on page 20*.
- If the safety devices are defective, speak to your Plymo servicing dealer.

### Chain brake and front hand guard

Your product has a chain brake that stops the saw chain if you get a kickback. The chain brake decreases the risk of accidents but only you can prevent them.

(Fig. 27)



**WARNING:** Do not engage in situations where there is a risk of kickback. Be careful when you use your product and make sure that the kickback zone of the guide bar does not touch an object.

(Fig. 28)

The chain brake engages (A) manually by your left hand or automatically by the inertia release mechanism. Push the front hand guard (B) forward to engage the chain brake manually. This movement starts a spring-loaded mechanism that stops the drive sprocket.

(Fig. 29)

How the chain brake is engaged is in relation to the force of the kickback and position of the product. If you get an intense kickback while the kickback zone is farthest away from you, the chain brake engages by the inertia release. If the kickback is small or the kickback zone is nearer you, the chain brake engages manually by your left hand.

(Fig. 30)

Use the chain brake as a parking brake when you start the product and when you move short distances. This decreases the risk that you or a person near you touches the saw chain.

(Fig. 31)

Pull the front hand guard rearward to disengage the chain brake.

(Fig. 32)

A kickback can be very sudden and intense. Most kickbacks are small and do not always engage the chain brake. If a kickback occurs when you use the product, hold tightly around the handles and do not let go.

(Fig. 33)

The front hand guard also decreases the risk to touch the saw chain if your hand lets go of the front handle.

(Fig. 34)

In the felling position you cannot engage the chain brake manually. The chain brake can in this position only be engaged by the inertia release mechanism.

(Fig. 35)

### Power trigger lockout

The power trigger lockout prevents accidental operation of the power trigger. If you push in the power trigger lockout (A) and keep it pushed in, it releases the power trigger (B). If you release the handle, the power trigger and the power trigger lockout move back to their initial positions.

(Fig. 36)

### Chain catcher

The chain catcher catches the saw chain if it breaks or comes loose. If you have the correct chain tension, the risk decreases. You also decrease the risk if you do the correct maintenance on the guide bar and saw chain. See *Assembly on page 14* and *Maintenance on page 19* for instructions.

(Fig. 37)

### Right hand guard

The right hand guard works as a protection for your hand if the saw chain breaks or comes loose. It also prevents interference from branches and twigs when you use the product.

(Fig. 38)

### Safety instructions for maintenance



**WARNING:** Read the warning instructions that follow before you do maintenance on the product.

- Disconnect the power plug before you do maintenance, other checks or assemble the product.
- The operator must only do the maintenance and servicing shown in this operator's manual. Turn to your servicing dealer for maintenance and servicing of a larger extension.

- If you do not do maintenance, it decreases the life cycle of the product and increases the risk of accidents.
- Special training is necessary for all servicing and repair work, especially for the safety devices on the product. If not all checks in this operator's manual are approved after you have done maintenance, turn to your servicing dealer. We guarantee that there are professional repairs and servicing available for your product.
- Only use original spare parts.

### Safety instructions for the cutting equipment



**WARNING:** Read the warning instructions that follow before you use the product.

- Only use approved guide bar/saw chain combinations and filing equipment. Refer to *Technical data on page 24* for instructions.
- Use protective gloves when you use or do maintenance on the saw chain. A saw chain that does not move can also cause injuries.

- Keep the cutting teeth correctly sharpened. Obey the instructions and use the recommended file gauge. A saw chain that is damaged or incorrectly sharpened increases the risk of accidents.

(Fig. 39)

- Keep the correct depth gauge setting. Obey the instructions and use the recommended depth gauge setting. Too large depth gauge setting increases the risk of kickback.

(Fig. 40)

- Make sure that the saw chain has the correct tension. If the saw chain is not tight against the guide bar, the saw chain can derail. An incorrect saw chain tension increases wear on the guide bar, saw chain and chain drive sprocket. Refer to *Accessories on page 25*.

(Fig. 41)

- Do maintenance on the cutting equipment regularly and keep it correctly lubricated. If the saw chain is not correctly lubricated, the risk of wear on the guide bar, saw chain and chain drive sprocket increases.

(Fig. 42)

## Assembly

### To assemble the guide bar and saw chain



**WARNING:** Always disconnect the power plug from the power source before you assemble or do maintenance on the product.

1. Disengage the chain brake. (Fig. 43)
2. Loosen the bar knob and remove the drive sprocket cover and the transportation guard (A). (Fig. 44)
3. Put the guide bar on top of the bar bolt. Steer the guide bar to its most rear position. Lift the saw chain above the drive sprocket and engage it in the groove on the guide bar. Start on the top edge of the guide bar.

4. Make sure that the edges of the cutters point forward on the top edge of the guide bar. (Fig. 45)
5. Install the drive sprocket cover and steer the chain adjuster pin to the hole in the guide bar.
6. Make sure that the drive links of the saw chain fit correctly on the drive sprocket.
7. Make sure that the saw chain is correctly engaged in the groove in the guide bar.
8. Apply tension to the saw chain. Refer to *To adjust the tension of the saw chain on page 22* for instructions.
9. Tighten the bar knob.

## Operation

### Introduction



**WARNING:** Read and understand the safety chapter before you use the product.

### To do a function check before you use the product

1. Do a check of the front hand guard (A) to make sure that it operates correctly and is not damaged. (Fig. 46)
2. Do a check of the rear hand guard (B) to make sure that it is not damaged.
3. Do a check of the power trigger (C) and the power trigger lockout (D) to make sure that they operate correctly and that they are not damaged.

4. Make sure that there is no oil on the front handle (E).
5. Do a check to make sure that all parts are correctly attached and not damaged or missing.
6. Do a check of the chain catcher (F) to make sure that it is not damaged.
7. Do a check of the chain tension (G).
8. Make sure that the saw chain stops when you release the power trigger (C).

## To use the correct chain oil



**WARNING:** Do not use waste oil, which can cause injury to you and the environment. Waste oil also causes damage to the oil pump, the guide bar and the saw chain.



**WARNING:** The saw chain can break if the lubrication of the cutting equipment is not sufficient. Risk of serious injury or death to the operator.



**WARNING:** Use the correct chain oil for this function to operate correctly. Speak to your servicing dealer when you select your chain oil.

- Use universal chain oil OLO023 for maximum saw chain life and to prevent negative effects on the environment. If universal chain oil OLO023 is not available, we recommend you to use a standard chain oil.
- Use a chain oil with good adherence to the saw chain.
- Use a chain oil with correct viscosity range that agrees with the air temperature.



**CAUTION:** In temperatures below 0°C/32°F some chain oils become too thick, which can cause damage to the oil pump components.

- Use the recommended cutting equipment. Refer to *Accessories on page 25*.
- Remove the cap to the chain oil tank.
- Fill the chain oil tank with chain oil.
- Attach the cap carefully.

(Fig. 47)

**Note:** To see where the chain oil tank is on your product, refer to *Product overview on page 8*.

## Kickback information



**WARNING:** A kickback can cause serious injury or death to the operator or others. To decrease the risk you must know the causes of kickback and how to prevent them.

A kickback occurs when the kickback zone of the guide bar touches an object. A kickback can occur suddenly and with large force, which throws the product in the direction of the operator.

(Fig. 28)

Kickback always occurs in the cutting plane of the guide bar. Usually, the product is thrown against the operator but can also move in a different direction. It is how you use the product when the kickback occurs that causes the direction of the movement.

(Fig. 48)

Kickback only occurs if the kickback zone of the guide bar touches an object. Do not let the kickback zone touch an object.

(Fig. 28)

A smaller bar tip radius decreases the force of the kickback.

Use a low kickback saw chain to decrease the effects of kickback. Do not let the kickback zone touch an object.



**WARNING:** No saw chain fully prevents kickback. Always obey the instructions.

## Common questions about kickback

- **Will the hand always engage the chain brake during a kickback?**

No. It is necessary to use some force to push the front hand guard forward. If you do not use the force necessary, the chain brake will not be engaged. You must also hold the handles of the product stable with two hands during work. If a kickback occurs, it is possible that the chain brake does not stop the saw chain before it touches you. There are also some positions in which your hand can not touch the front hand guard to engage the chain brake.

- **Will the inertia release mechanism always engage the chain brake during kickback?**

No. First, the chain brake must operate correctly. Refer to *Maintenance and checks of the safety devices on the product on page 20* for instructions about how to do a check of the chain brake. We recommend you to do this each time before you use the product. Second, the force of the kickback must be large to engage the chain brake. If the chain brake is too sensitive, it can engage during rough operation.

- **Will the chain brake always protect me from injury during a kickback?**

No. The chain brake must operate correctly to give protection. The chain brake must also be engaged during a kickback to stop the saw chain. If you are near the guide bar, it is possible that the chain brake does not have time to stop the saw chain before it hits you.



**WARNING:** Only you and the correct working technique can prevent kickbacks.

## To start the product

1. Do a check of the power trigger and power trigger lockout. Refer to *To do a check of the power trigger lockout on page 20*.
2. Engage the chain brake. (Fig. 49)
3. Connect the power plug to a power source.
4. Disengage the chain brake. (Fig. 43)
5. Hold the product in both handles. Push in the power trigger lockout and the power trigger.
6. Push in the power trigger lockout (A) and the power trigger (B), then immediately release the power trigger lockout. (Fig. 36)

## To stop the product

The product stops when you release the power trigger. If the product does not stop when you release the power trigger, speak to an approved service agent.

1. Release the power trigger.
2. Engage the chain brake.
3. Disconnect the power plug from the power source.

## Pull stroke and push stroke

You can cut through wood with the product in 2 different positions.

- To cut on the pull stroke is when you cut with the bottom of the guide bar. The saw chain pulls through the tree when you cut. In this position you have better control of the product and the position of the kickback zone.

(Fig. 50)

- To cut on the push stroke is when you cut with the top of the guide bar. The saw chain pushes the product in the direction of the operator.

(Fig. 51)



**WARNING:** If the saw chain is caught in the trunk, the product can be pushed at you. Hold the product tightly and make sure that the kickback zone of the guide bar does not touch the tree and causes a kickback.

(Fig. 52)

## To use the cutting technique



**WARNING:** Use full power when you cut and decrease the speed to idle speed after each cut.



**CAUTION:** Do not let the motor operate for too long without load. This can cause damage to the motor.

1. Put the trunk on a saw horse or runners. (Fig. 53)



**WARNING:** Do not cut trunks in a pile. That increases the risk of kickback and can cause serious injury or death.

2. Remove the cut pieces from the work area.



**WARNING:** Cut pieces in the work area increase the risk of kickback and that you cannot keep your balance.

## To use the spiked bumper

1. Push the spiked bumper into the trunk of the tree.
2. Apply full power and rotate the product. Keep the spiked bumper against the trunk. This procedure makes it easier to apply the force necessary to cut through the trunk. (Fig. 54)

## To cut a trunk on the ground

1. Cut through the trunk on the pull stroke. Keep full power but be prepared for sudden accidents. (Fig. 55)



**WARNING:** Make sure that the saw chain does not touch the ground when you complete the kerf.

2. Cut approximately  $\frac{2}{3}$  through the trunk and then stop. Turn the trunk and cut from the opposite side. (Fig. 56)

## To cut a trunk that has support on one end



**WARNING:** Make sure that the trunk does not break during cutting. Obey the instructions below.

(Fig. 57)

1. Cut on the push stroke approximately  $\frac{1}{3}$  through the trunk.
2. Cut through the trunk on the pull stroke until the two kerfs touch. (Fig. 58)



## To cut a trunk that has support on two ends



**WARNING:** Make sure that the saw chain does not get caught in the trunk during cutting. Obey the instructions below.

(Fig. 59)

1. Cut on the pull stroke approximately  $\frac{1}{4}$  through the trunk.
2. Cut through the remaining part of the trunk on the push stroke to complete the cut. (Fig. 60)



**WARNING:** Stop the motor if the saw chain gets caught in the trunk. Use a lever to open up the kerf and remove the product. Do not try to pull the product out by hand. This can result in injury when the product suddenly breaks free.

## To use the limbing technique

**Note:** For thick branches, use the cutting technique. Refer to *To use the cutting technique on page 16*.



**WARNING:** There is a high accident risk when you use the limbing technique. Refer to *Kickback information on page 15* for instructions how to prevent kickback.



**WARNING:** Cut limbs one by one. Be careful when you remove small limbs and do not cut bushes or many small limbs at the same time. Small limbs can get caught in the saw chain and prevent safe operation of the product.

**Note:** If it is necessary, cut the limbs piece by piece. Cut the smaller branches (A) and (B) before you cut the limb near the trunk (C).

(Fig. 61)

1. Remove the limbs on the right side of the trunk.
  - a) Keep the guide bar on the right side of the trunk and keep the body of the product against the trunk.
  - b) Select the applicable cutting technique for the tension in the branch. (Fig. 62)



**WARNING:** If you are not sure about how to cut the branch, speak to a professional chainsaw operator before you continue.

2. Remove the limbs on the top of the trunk.

- a) Keep the product on the trunk and let the guide bar move along the trunk.
  - b) Cut on the push stroke. (Fig. 63)
3. Remove the limbs on the left side of the trunk.
    - a) Select the applicable cutting technique for the tension in the branch. (Fig. 64)



**WARNING:** If you are not sure about how to cut the branch, speak to a professional chainsaw operator before you continue.

Refer to *To cut trees and branches that are in tension on page 19* for instructions on how to cut branches that are in tension.

## To use the tree felling technique



**WARNING:** You must have experience to fell a tree. If possible, engage in a training course in chainsaw operation. Speak to an operator with experience for more knowledge.

## To keep a safe distance

1. Make sure that persons around you keep a safe distance at a minimum of 2  $\frac{1}{2}$  tree lengths. (Fig. 65)
2. Make sure that no person is in the risk zone before or during felling. (Fig. 66)

## To calculate the felling direction

1. Examine in which direction it is necessary for the tree to fall. The goal is to fell it in a position where you can limb and cut the trunk easily. It is also important that you are stable on your feet and can move about safely.



**WARNING:** If it is dangerous or not possible to fell the tree in its natural direction, fell the tree in a different direction.

2. Examine the natural fall direction of the tree. For example the tilt and bend of the tree, wind direction, the location of the branches and weight of snow.
3. Examine if there are obstacles, for example other trees, power lines, roads and/or buildings around.
4. Look for signs of damage and rot in the stem.



**WARNING:** Rot in the stem can mean a risk that the tree falls before you complete the cutting.

5. Make sure the tree has no damaged or dead branches that can break off and hit you during felling.

6. Do not let the tree fall onto a different standing tree. It is dangerous to remove a caught tree and there is a high accident risk. Refer to *To free a trapped tree on page 19*. (Fig. 67)



**WARNING:** During critical felling operations, lift your hearing protection immediately when the sawing is complete. It is important that you hear sounds and warning signals.

### To clear the trunk and prepare your path of retreat

Cut off all branches from your shoulder height and down.

1. Cut on the pull stroke from the top down. Make sure that the tree is between you and the product. (Fig. 68)
2. Remove undergrowth from the work area around the tree. Remove all cut off material from the work area.
3. Do a check of the area for obstacles such as stones, branches and holes. You must have a clear path of retreat when the tree starts to fall. Your path of retreat must be approximately 135 degrees away from the felling direction.

1. The danger zone
2. The path of retreat
3. The felling direction

(Fig. 69)

### To fell a tree

Flymo recommends you to make the directional cuts and then use the safe corner method when you fell a tree. The safe corner method helps you to make a correct felling hinge and control the felling direction.



**WARNING:** Do not fell trees with a diameter that is more than two times larger than the guide bar length. For this, you must have special training.

### The felling hinge

The most important procedure during tree felling is to make the correct felling hinge. With a correct felling hinge, you control the felling direction and make sure that the felling procedure is safe.

The thickness of the felling hinge must be equal and a minimum of 10% of the tree diameter.



**WARNING:** If the felling hinge is incorrect or too thin, you have no control of the felling direction.

(Fig. 70)

### To make the directional cuts

1. Make the directional cuts. Run the directional cuts 1/4 of the diameter of the tree. Make a 45° angle between the top cut and bottom cut.
  - a) Make the top cut first. Align the felling direction mark (A) of the product with the felling direction of the tree (B). Stay behind the product and keep the tree on your right side. Cut with a pull stroke.
  - b) Make the bottom cut. Make sure that the end of the bottom cut is at the same point as the end of the top cut. (Fig. 71)
2. Make sure that the directional cut line is perfectly horizontal and at right angles (90°) to the felling direction. The directional cut line goes through the point where the two directional cuts touch. (Fig. 72)

### To use the safe corner method

The felling cut must be made slightly above the directional cut.

(Fig. 73)



**WARNING:** Be careful when you cut with the guide bar tip. Start to cut with the lower section of the guide bar tip as you make a bore cut into the trunk.

(Fig. 74)

1. If the usable cutting length is longer than the tree diameter, do these steps (a-d).
  - a) Make a bore cut straight into the trunk to complete the felling hinge width. (Fig. 75)
  - b) Cut on the pull stroke until 1/3 of the trunk is left.
  - c) Pull the guide bar 5-10 cm/2-4 in rearward.
  - d) Cut through the remaining of the trunk to complete a safe corner that is 5-10 cm/2-4 in wide. (Fig. 76)
2. If the usable cutting length is shorter than the tree diameter, do these steps (a-d).
  - a) Make a bore cut straight into the trunk. The bore cut must extend 3/5 of the tree diameter.
  - b) Cut on the pull stroke through the remaining trunk. (Fig. 77)
  - c) Cut straight into the trunk from the other side of the tree to complete the felling hinge.
  - d) Cut on the push stroke, until 1/3 of the trunk is left, to complete the safe corner. (Fig. 78)
3. Put a wedge in the kerf straight from behind. (Fig. 79)
4. Cut off the corner to make the tree fall.

**Note:** If the tree does not fall, hit the wedge until it does.

- When the tree starts to fall, use the path of retreat to move away from the tree. Move a minimum of 5 m/15 ft away from the tree.

### To free a trapped tree



**WARNING:** It is very dangerous to remove a trapped tree and there is a high accident risk. Keep out of the risk zone and do not try to fell a trapped tree.

(Fig. 80)

The safest procedure is to use one of the following winches:

- Tractor-mounted

(Fig. 81)

- Portable

(Fig. 82)

### To cut trees and branches that are in tension

- Figure out which side of the tree or branch that is in tension.
- Figure out where the point of maximum tension is. (Fig. 83)
- Examine which is the safest procedure to release the tension.

**Note:** In some situations the only safe procedure is to use a winch and not your product.

- Keep a position where the tree or branch can not hit you when the tension is released. (Fig. 84)
- Make one or more cuts of sufficient depth necessary to decrease the tension. Cut at or near the point of maximum tension. Make the tree or branch break at the point of maximum tension. (Fig. 85)



**WARNING:** Do not cut straight through a tree or branch that is in tension.



**WARNING:** Be very careful when you cut a tree that is in tension. There is a risk that the tree moves quickly before or after you cut it. Serious injury can occur if you are in an incorrect position or if you cut incorrectly.

- If you must cut across tree/branch, make 2 to 3 cuts, 1 in. apart and with a depth of 2 in. (Fig. 86)
- Continue to cut more into the tree until the tree/branch bends and the tension is released. (Fig. 87)
- Cut the tree/branch from the opposite side of the bend, after the tension is released.

## Maintenance

### Introduction



**WARNING:** Read and understand the safety chapter before you do maintenance on the product.

The following is a list of the maintenance steps that you must do on the product. See *Maintenance on page 19* for more information.

### Maintenance schedule



**WARNING:** Disconnect the power plug from the power source before you do maintenance.

Maintenance	Before use	Weekly	Monthly
Clean the external parts of the product.	X		
Make sure that the power trigger and the power trigger lockout function correctly from a safety point of view.	X		
Clean the chain brake and make sure that it operates safely. Make sure that the chain catcher is not damaged. Replace it if necessary.	X		
Turn the guide bar for more equal wear. Make sure that the lubrication hole in the guide bar is not clogged. Clean the bar groove.	X		

Maintenance	Before use	Weekly	Monthly
Make sure that the cutter and cutter guard have no cracks and that they are not damaged. Replace the cutter or cutter guard if they have cracks or if they have been exposed to impact.	X		
Make sure that the guide bar and saw chain have sufficient oil.	X		
Do a check of the saw chain. Look for cracks and make sure that the saw chain is not rigid or unusually worn. Replace if necessary.	X		
Sharpen the saw chain. Do a check of its tension and condition. Do a check for wear on the drive sprocket and replace is necessary.	X		
Clean the air inlet on the product.	X		
Make sure that the screws and nuts are tight.	X		
Make sure that the power cable it is not damaged.	X		
Use a file to remove burrs from the edges of the guide bar.		X	
Empty and clean the oil tank.			X

## Maintenance and checks of the safety devices on the product

### To do a check of the front hand guard

Regularly do a check of the front hand guard and the inertia brake release.

1. Make sure that the front hand guard is not damaged and that there are no defects, such as cracks. (Fig. 88)
2. Make sure that the front hand guard moves freely and that it is attached safely to the product. (Fig. 89)
3. Put the product, with the motor off, on a stump or other stable surface.
4. Hold the rear handle and let go of the front handle. Let the product fall against the stump. (Fig. 90)
5. Make sure that the chain brake engages as the guide bar hits the stump.

### To do a check of the brake trigger

1. Put the product on stable ground and start it. See *Operation on page 14*.



**WARNING:** Make sure that the saw chain does not touch the ground or other objects.

2. Wrap your fingers and thumbs around the handles and hold the product tight. (Fig. 33)
3. Apply full power and tilt your left wrist against the front hand guard to engage the chain brake. The saw chain must stop immediately. (Fig. 91)



**WARNING:** Do not let go of the front handle!

### To do a check of the power trigger lockout

1. Make sure that the power trigger and power trigger lockout move freely and that the return spring operates correctly. (Fig. 92)
2. Push in the power trigger lockout. Keep the power trigger lockout pushed in and make sure that it goes back to its initial position when you release it.
3. Make sure that the power trigger is locked at the idle position when the power trigger lockout is released. (Fig. 93)
4. Start the product and apply full power.
5. Release the power trigger and make sure that the saw chain stops and stays stationary.



**WARNING:** If the saw chain rotates when the power trigger is in the idle position, speak to your servicing dealer.

### To do a check of the chain catcher

1. Make sure that there is no damage on the chain catcher.
2. Make sure that the chain catcher is stable and attached to the body of the product. (Fig. 94)

### To clean the cooling system

The cooling system keeps the motor temperature down. The cooling system includes the air intake on the left side of the product and a fan on the motor.

1. Clean the cooling system with a brush weekly or more frequently if it is necessary. (Fig. 95)
2. Make sure that the cooling system is not dirty or blocked.



**CAUTION:** A dirty or blocked cooling system can cause the product to become too hot. This causes damage to the product.

## To sharpen the saw chain

### Information about the guide bar and saw chain



**WARNING:** Use protective gloves when you use or do maintenance on the saw chain. A saw chain that does not move can also cause injuries.

Replace a worn or damaged guide bar or saw chain with the guide bar and saw chain combination recommended by Flymo. This is necessary to keep the safety functions of the product. Refer to *Accessories on page 25*, for a list of replacement bar and chain combinations that we recommend.

- Guide bar length, in/cm. Information about the guide bar length can usually be found on the rear end of the guide bar.

(Fig. 96)

- Number of teeth on bar tip sprocket (T).

(Fig. 97)

- Chain pitch, in. The distance between the drive links of the saw chain must align with the distance of the teeth on the bar tip sprocket and drive sprocket.

(Fig. 98)

- Number of drive links. The number of drive links is decided by the type of guide bar.

(Fig. 99)

- Bar groove width, in/mm. The groove width in guide bar must be the same as the chain drive links width.

(Fig. 100)

- Chain oil hole and hole for chain tensioner. The guide bar must align with product.

(Fig. 101)

- Drive link width, mm/in.

(Fig. 102)

### General information about how to sharpen the cutters

Do not use a blunt saw chain. If the saw chain is blunt, you must apply more pressure to push the guide bar

through the wood. If the saw chain is very blunt, there will be no wood chips but sawdust.

A sharp saw chain eats through the wood and the wood chips becomes long and thick.

The cutting tooth (A) and the depth gauge (B) together makes the cutting part of the saw chain, the cutter. The difference in height between the two gives the cutting depth (depth gauge setting).

(Fig. 103)

When you sharpen the cutter, think about the following:

- Filing angle.

(Fig. 104)

- Cutting angle.

(Fig. 105)

- File position.

(Fig. 106)

- Round file diameter.

(Fig. 107)

It is not easy to sharpen a saw chain correctly without the correct equipment. Use Flymo file gauge. This will help you to keep maximum cutting performance and the kickback risk at a minimum.



**WARNING:** The force of the kickback increases a lot if you do not follow the sharpening instructions.

**Note:** Refer to *Accessories on page 25* for information about sharpening of the saw chain.

### To sharpen the cutters

1. Use a round file and a file gauge to sharpen the cutting teeth. (Fig. 108)

**Note:** Refer to *Accessories on page 25* for information about which file and gauge that Flymo recommends for your saw chain.

2. Apply the file gauge correctly on to the cutter. Refer to the instruction supplied with the file gauge.
3. Move the file from the inner side of the cutting teeth and out. Decrease the pressure on the pull stroke. (Fig. 109)
4. Remove material from one side of all the cutting teeth.
5. Turn the product around and remove material on the other side.
6. Make sure that all cutting teeth are the same length.

## General information about how to adjust the depth gauge setting

The depth gauge setting (C) decreases when you sharpen the cutting tooth (A). To keep maximum cutting performance you must remove filing material from the depth gauge (B) to receive the recommended depth gauge setting. See *Accessories on page 25* for instructions about how to receive the correct depth gauge setting for your saw chain.

(Fig. 110)



**WARNING:** The risk of kickback increases if the depth gauge setting is too large!

## To adjust the depth gauge setting

Before you adjust the depth gauge setting or sharpen the cutters, refer to *To sharpen the cutters on page 21*, for instructions. We recommend you to adjust the depth gauge setting after each third operation that you sharpen the cutting teeth.

We recommend that you use our depth gauge tool to receive the correct depth gauge setting and bevel for the depth gauge.

(Fig. 111)

1. Use a flat file and a depth gauge tool to adjust the depth gauge setting. Only use Flymo depth gauge tool to get the correct depth gauge setting and bevel for the depth gauge.
2. Put the depth gauge tool on the saw chain.

**Note:** See the package of the depth gauge tool for more information about how to use the tool.

3. Use the flat file to remove the part of the depth gauge that extends through the depth gauge tool. (Fig. 112)

## To adjust the tension of the saw chain



**WARNING:** A saw chain with an incorrect tension can come loose from the guide bar and cause serious injury or death.

A saw chain becomes longer when you use it. Adjust the saw chain regularly.

1. Loosen the bar knob that holds the drive sprocket cover. (Fig. 113)
2. Lift the front of the guide bar and turn the chain tensioning wheel clockwise to increase the tension of the saw chain. Increase the tension of the saw chain until the saw chain is tight against the guide bar. (Fig. 114)
3. Tighten the bar knob and lift the front of the guide bar at the same time.

4. Make sure that you can pull the saw chain around freely by hand and that it does not hang from the guide bar. (Fig. 115)

## To do a check of the saw chain lubrication

Do a check of the saw chain lubrication after every 2–3 hours of operation.

1. Do a check of the oil channel in the guide bar to make sure that it is not blocked. Clean the oil channel if it is necessary. (Fig. 116)
2. Do a check of the groove in the edge of the guide bar to make sure that it is clean. Clean the groove if it is necessary. If the groove is worn or damaged the guide bar must be replaced. Speak to an approved service agent. (Fig. 117)
3. Do a check of the chain drive sprocket. Refer to *To do a check of the chain drive sprocket on page 22*.
4. Make sure that the sprocket in the tip of the guide bar turns freely. If it is necessary, lubricate the sprocket with bearing grease in the lubrication hole in the tip of the guide bar. Make sure that the lubrication hole is clean and not blocked. (Fig. 118)
5. If the saw chain lubrication does not work after following the steps above, speak to your servicing dealer.

## To do a check of the chain drive sprocket

- Examine the chain drive sprocket for wear. If it is necessary to replace the chain drive sprocket, speak to an approved service agent. (Fig. 119)

## To examine the cutting equipment

1. Make sure that there are no cracks in rivets and links and that no rivets are loose. Replace if it is necessary. (Fig. 120)
2. Make sure that the saw chain is easy to bend. Replace the saw chain if it is rigid.
3. Compare the saw chain with a new saw chain to examine if the rivets and links are worn.
4. Replace the saw chain when the longest part of the cutting tooth is less than 4 mm/0.16 in. Also replace the saw chain if there are cracks on the cutters. (Fig. 121)

## To do a check of the guide bar

1. Make sure that the oil channel is not blocked. Clean if it is necessary. (Fig. 122)
2. Examine if there are burrs on the edges of the guide bar. Remove the burrs using a file. (Fig. 123)
3. Clean the groove in the guide bar. (Fig. 117)
4. Examine the groove in the guide bar for wear. Replace the guide bar if it is necessary. (Fig. 124)

5. Examine if the guide bar tip is rough or very worn. (Fig. 125)
6. Make sure that the bar tip sprocket turns freely and that the lubricating hole in the bar tip sprocket is not blocked. Clean and lubricate if it is necessary. (Fig. 126)
7. Turn the guide bar daily to extend its life cycle. (Fig. 127)

---

## Troubleshooting

---

### Troubleshooting

Problem	Possible cause	Action
The product does not start.	There is no power in the mains.	Make sure that there is power in the mains.
	The power plug is not connected correctly.	Make sure that the power plug is connected correctly.
	The power cord, power plug, or extension cord is damaged.	Make sure that the power cord, power plug and eventual extension cord are not damaged. If the power cord is damaged or defective, speak to an approved service agent.
	The saw chain brake is engaged.	Disengage the chain brake.
	The cut-out switch is engaged.	Disengage the cut-out switch.
	The product is defective.	Speak to an approved service agent.
The motor does not turn or loses power.	The saw chain or the guide bar is not assembled correctly.	Make sure that the saw chain and the guide bar are assembled correctly.
	The product is defective.	Speak to an approved service agent.
	The saw chain is not tensioned correctly.	Make sure that the saw chain has the correct tension.
The motor operates irregularly or at reduced speed.	The product is defective.	Speak to an approved service agent.
The cutting result is unsatisfactory	The saw chain or the guide bar is not assembled correctly.	Make sure that the saw chain and the guide bar are assembled correctly.
	The saw chain is not tensioned correctly.	Make sure that the saw chain has the correct tension.
	The saw chain is not lubricated.	Make sure that the saw chain is lubricated. Refer to <i>To do a check of the saw chain lubrication on page 22.</i>
	The saw chain is not sharp.	Sharpen the saw chain. Refer to <i>To sharpen the saw chain on page 21.</i>
The chain brake is engaged but the saw chain does not stop.	The chain brake is defective.	Do not operate a product with a defective chain brake. Speak to an approved service agent.

## Transportation, storage and disposal

### Transportation and storage

- Obey the special requirement on package and labels for commercial transportation, including by third parties and forwarding agents.
- Speak to a person with special training in dangerous material before you send the product. Obey all applicable national regulations.
- Clean the product and do a full servicing before you put the product in storage for a long time.
- Use the transportation guard on the product to prevent injuries or damage on the product during transportation and storage.
- Attach the product safely during transportation.
- Keep the product in a cool and dry environment and away from children when it is not in use. Do not put the product in storage outdoors.

## Technical data

### Technical data

<b>EasiSaw 350E</b>	
<b>Motor</b>	
Type	AC motor
<b>Lubrication system</b>	
Oil tank capacity, l/cm <sup>3</sup>	0.26/260
Type of oil pump	Automatic
<b>Weight</b>	
Weight, kg	4.3
<b>Noise emissions <sup>1</sup></b>	
Sound power level, measured dB(A)	104
Sound power level, guaranteed L <sub>WA</sub> dB(A)	107
<b>Sound levels <sup>2</sup></b>	
Equivalent sound pressure level at the operator's ear, measured according to EN 62841-1, dB(A)	97
<b>Vibration levels <sup>3</sup></b>	
Front handle m/s <sup>2</sup>	4.7
Rear handle m/s <sup>2</sup>	6.5
<b>Saw chain/guide bar</b>	

<sup>1</sup> Noise emissions in the environment measured as sound power (L<sub>WA</sub>) in conformity with EC directive 2000/14/EC and EN ISO 22868 has a typical statistical dispersion (standard deviation) of 3 dB(A).

<sup>2</sup> Reported data for sound pressure level for the machine has a typical statistical dispersion (standard deviation) of 3 dB (A).

<sup>3</sup> Vibration level, according to EN 62841-4-1. Reported data for vibration level has a typical statistical dispersion (standard deviation) of ± 1.5 m/s<sup>2</sup>. Declared vibration data from measurements when the machine is fitted with a bar length and recommended chain type. If the machine is fitted with a different bar length, the vibration level may vary by max ± 1.5 m/s<sup>2</sup>.



	<b>EasiSaw 350E</b>
Type of drive sprocket/number of teeth	Spur/6
Maximum chain speed, m/s	13.5
Recommended bar lengths, in/cm	14/35

## Accessories

### Guide bar and saw chain combinations







The following cutting attachments are approved for Flymo EasiSaw 350E.

Guide bar					Saw chain	
Type	Length, in	Chain pitch, in	Gauge, mm	Max. nose radius	Type	Length, drive links (no.)
536-550201	14	3/8	1.3	7T	530 05 15-38	52

### Filing equipment and filing angles

Using Flymo file gauge will give you the correct filing angles. We recommend you to always use a Flymo file gauge to restore the sharpness of the saw chain. The part numbers are given in the table below.

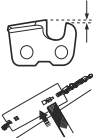
If you do not know which saw chain you have on your product, turn to your servicing dealer.

							
93	5/32 in/4.0 mm	60°	30°	0°	0.025 in/0.65 mm	587 80 67-01	587 80 90-01

---

## Declaration of Conformity

---

### EU Declaration of conformity

We, **Husqvarna AB**, SE-561 82 Huskvarna, Sweden, tel:  
+46-36-146500, declare on our sole responsibility that  
the product:

<b>Description</b>	Mains-supplied chainsaw
<b>Brand</b>	Flymo
<b>Type / Model</b>	EasiSaw 350E
<b>Identification</b>	Serial numbers dating from 2022 and onwards

complies fully with the following EU directives and  
regulations:

<b>Regulation</b>	<b>Description</b>
2006/42/EC	"relating to machinery"
2014/30/EU	"relating to electromagnetic compatibility"
2011/65/EU	"on the restriction of the use of certain hazardous substances in electrical and electronic equipment "
2000/14/EC	"relating to the noise emissions in the environment"

and that the following standards and/or technical  
specifications are applied: EN 62841-1:2015, EN  
62841-4-1:2020, EN IEC 63000:2018, EN IEC  
55014-1:2021, EN IEC 55014-2:2021, EN IEC  
61000-3-2:2019+A1, EN 61000-3-3:2013+A1+A2.

Certificate numbers: BM 50558443 0001

Notified body: TÜV Rheinland LGA Products GmbH,  
Tillystrasse 2, D-90431 Nuernberg, Germany, 0197 has  
carried out EC type examination in accordance with the  
machinery directive's (2006/42/EC) article 12, clause 3b.

For information relating to noise emissions, refer to  
*Technical data on page 24.*

Huskvarna, 2022-08-02



Claes Losdal, R&D manager, Husqvarna AB

Responsible for technical documentation



## UK Declaration of conformity

We, **Husqvarna AB**, SE-561 82 Huskvarna, Sweden, tel: +46-36-146500, declare on our sole responsibility that the product:

<b>Description</b>	Mains-supplied chainsaw with an electrical motor.
<b>Brand</b>	Flymo
<b>Type / Model</b>	EasiSaw 350E
<b>Identification</b>	Serial numbers dating from 2022 and onwards

complies fully with the following UK regulations:

<b>Description</b>
The Supply of Machinery (Safety) Regulations 2008
Electromagnetic Compatibility Regulations 2016
The Noise Emission in the Environment by Equipment for use Outdoors Regulations 2001, schedule 8
The Restriction of the Use of Certain Hazardous Substances in Electrical and Electronic Equipment Regulations 2012

and that the following standards and/or technical specifications are applied: EN 62841-1:2015, EN 62841-4-1:2020, EN IEC 63000:2018, EN IEC 55014-1:2021, EN IEC 55014-2:2021, EN IEC 61000-3-2:2019+A1, EN 61000-3-3:2013+A1+A2.

Approved body: TÜV Rheinland UK Ltd., Friars Gate (third floor), 1011 Stratford Road, Shirley, Solihull, B90 4BN, UK, UK approved body No. 2571. The certificate number is A6 50558444 0001.

For information relating to noise emissions, refer to *Technical data on page 24*.

Huskvarna, 2022-08-02



Claes Losdal, R&D Manager, Husqvarna AB

Responsible for technical documentation

**UK  
CA**

UK Importer:  
Husqvarna UK Ltd  
Preston Road, Co. Durham  
DL5 6UP



[www.flymo.com](http://www.flymo.com)

Original instructions



1142984-26 Rev. A



2022-09-22